

# Sketch 4

## RECESSED - RGB+W

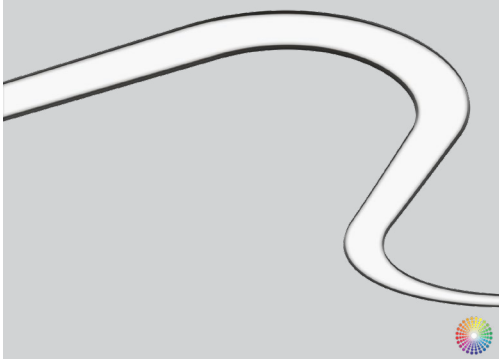

### ● INTERSECTIONS

Min 45 degree fully lit corner, intersections are one piece lenses with no seams at the intersection.



Project \_\_\_\_\_  
 Type \_\_\_\_\_  
 Notes \_\_\_\_\_

### ● PERFORMANCE PER LINEAR FOOT AT 3500K WHITE

	NOMINAL LUMEN OUTPUT DIRECT	INPUT WATTS*	EFFICACY
Sketch 4	1000lm/ft	13.11 W/ft	75.5 lm/W

Please consult factory for other lumen output and wattage.

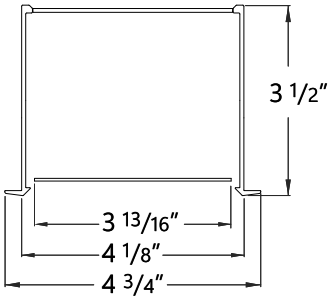

DF drywall flange shown

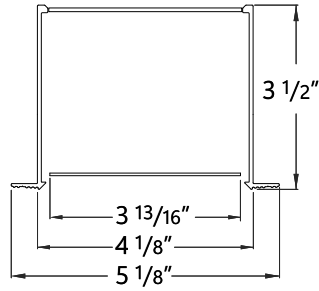

DS drywall spackle flange shown

### Ordering Guide

**Example: SK4R-FF(100100\*)-AL(7'8")-1000-90-CTRGBW35-SO-BLK-120-CT(DMX)-1-DF**

\*Project reference number provided by Axis



SK4R		PATTERNS AND FORMS		TOTAL LENGTH, CORNER QTY.		LUMENS/FT	
<b>PRODUCT ID</b>	Sketch 4 Recessed RGB+W	<b>FF(#)</b>	free form pattern (project reference #)**	<b>AL('XX')</b>	specify total linear length in feet (4 ft minimum)	<b>1000</b>	1000 lm/ft
		<b>SSQ(L, R)</b>	soft square (length, radius)*	<b>+INT(#)</b>	intersection (qty.)		
		<b>SR (LxL, R)</b>	soft rectangle (length x width, radius)*	<b>+CRN(#)</b>	sharp corner (qty.)		
		<b>OV(LxL)</b>	oval (length x width)				
		<b>CIR(R)</b>	circle (radius)				
		<b>ARC(R, Deg.)</b>	arc (radius, degrees)				
		<b>LIN(L)</b>	linear (length)				
See page 3 for ordering examples. Min radius 18" and min 4 ft sections. * 4 foot minimum straight sections. **Please provide pattern drawing, and specify project reference number. Factory is available for assistance. Various 2, 3 and 4 leg fully lit intersections and regular lit corners (min 45 degrees) available.							

CRI		COLOUR TEMP.		SHIELDING		FINISH		VOLTAGE		DRIVER	
<b>90</b>	high efficacy 90 CRI	<b>CTRGBW30</b>	RGB+30K White - Color Tuning	<b>SO</b>	spotless lens	<b>AP</b>	aluminum paint	<b>120</b>	120 V	<b>CT(DMX)</b>	color tuning driver - remote only
		<b>CTRGBW35</b>	RGB+35K White - Color Tuning			<b>W</b>	white	<b>277</b>	277 V		
		<b>CTRGBW40</b>	RGB+40K White - Color Tuning			<b>BLK</b>	black	<b>UNV</b>	universal		
						<b>C</b>	custom				

CIRCUITS		MOUNTING		OTHER (OPT.)		CUSTOM (OPT.)	
<b>1</b>	1 circuit	<b>DF</b>	drywall flange	<b>FW</b>	flex whip (6' std)*	<b>C</b>	custom
<b>+E(#)</b>	emergency circuit *	<b>DS</b>	drywall spackle flange				
* Specify quantity				* Other lengths available; please consult factory.		Please specify	

### How to Specify Standard Forms

**Note:** The center line indicates the diameter at the center of the curve. Regardless to the mounting style, the center line remains the same. This is the dimension that should be used when planning a layout.

#### Defining SR - Soft Rectangle shape

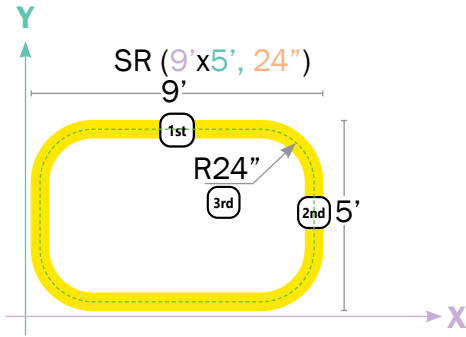

**Note:** The first number will always define the width, the second - the length. Third number will define the radius of the corner curvature.

#### Defining SSQ - Soft Square shape

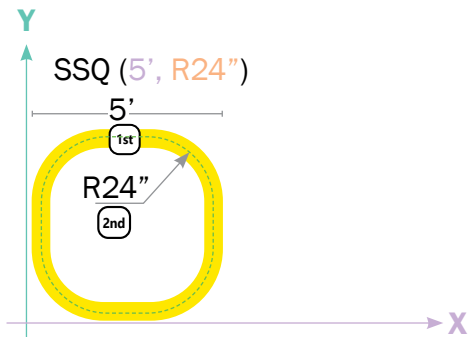

**Note:** The first number will define the width. (All sides are the same length). The second number will define the radius of the corners curvature.

#### Defining OV - Oval shape

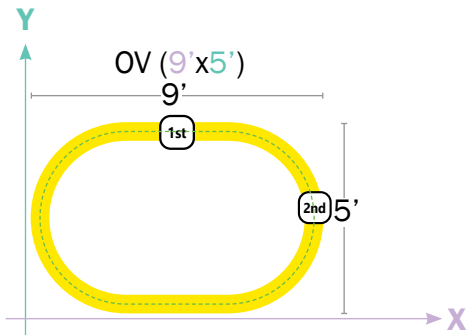

**Note:** The first number will always define the length. Second number will define the width of the oval shape.

#### Defining CIR - Circular shape

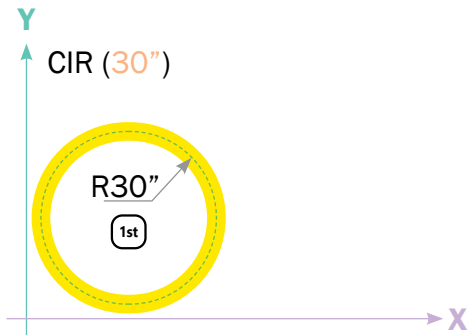

**Note:** The number will define the radius of the circle.

#### Defining ARC - Arc shape

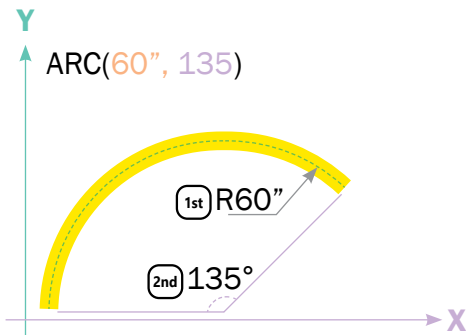

**Note:** The first number will define the radius of the circle. The second number will define desired arc degree

RADIUS	
R18	18 inch radius
R24	24 inch radius
R30	30 inch radius
R48	48 inch radius
R60	60 inch radius
R72	72 inch radius
R80	80 inch radius
R(XX")	any radius above 12 inch

### CONSTRUCTION

<b>Housing</b>	Extruded aluminum (0.075" nominal)
<b>Interior reflectors</b>	Sheet aluminum (20 gauge)
<b>Mounting brkts.</b>	Die cast aluminum (0.10" nominal)
<b>Joining brackets.</b>	Die cast aluminum (0.10" nominal)
<b>Incap &amp; Cross Brkt.</b>	Die cast aluminum (0.10" nominal)

### SHEILDING

**Spotless Lens** Acrylic (0.06" thick).

### FINISH

Highly reflective, white powder coat finish paint for high efficiency. Matte texture to diffuse glare and lamp image on the surface within the optical chamber exterior. Custom finishes are also available.

### WEIGHT

Approximately 1.75lbs/ft = 0.8kg/ft (linear)

### DMX CONNECTION

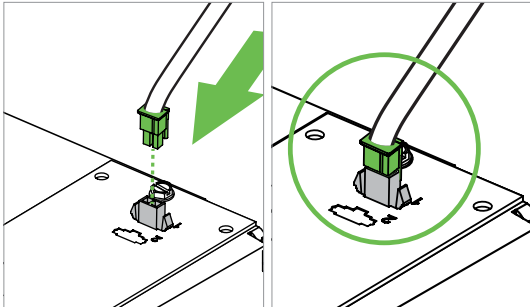

Illustration shows DMX cables that run to luminaire using MOLEX® Quick Connect plug for easy wiring.

Appropriate cables include (but are not limited to) the following:

PLENUM RATED	NON-PLENUM RATED
Belden 82842	Belden 9842 Liberty 24-2P-485
Belden 89842	
Liberty 24-1P-P485	
Liberty 24-2P-P485	

The maximum recommended run length between a single fixture and the DMX controller or splitter where the signal originates (or is boosted in the case of a splitter) is 1000 ft including any cable length between a ceiling canopy and the fixture.

The maximum recommended bus run length between two daisy-chained DMX controlled fixtures is 300 ft.

### ELECTRICAL

<b>Color Tuning CT driver</b>	DMX - Standard
<b>Emergency</b>	Emergency circuit optional.
<b>Input Voltage</b>	120V, 277V, UNV.

**i** Incorporating these components may have limitations or affect the length of the luminaire. Please contact factory for more details.

### LED SYSTEM

<b>CRI</b>	High efficacy 90 color rendering index.
<b>CRI Color Tuning</b>	90 CRI for CTRGBW. <b>Note: RGB+W allows you to select the 'white point' (CCT) + CRI, delivering a more flexible and powerful white than standard RGBW.</b>
<b>CCT Color Tuning</b>	30 (3000K) 35 (3500K) 40 (4000K)
<b>CCT Axitune Systems</b>	<a href="#">Consult Axitune technical sheet for more information on color technology.</a>
<b>LED life</b>	Minimum 50,000h with 85% of lumen maintenance in 25°C ambient temperature, in compliance with IES LM-80 testing measurements.
<b>Thermal Management</b>	Aluminum housing acting as the heat sink to maximize life.
<b>Environment</b>	Dry and damp rated in operating ambient temperatures of 0-40°C (32-104F).

### APPROVALS

Certified to CSA standards   
Meets NYC requirements  
Suitable for damp locations, indoor only.

### WARRANTY

Axis Lighting will warrant defective LEDs, boards, and drivers for 5 years from date of purchase. Warranty is valid if luminaire is installed and used according to specifications. If defective, Axis will send replacement boards or drivers at no cost along with detailed replacement instructions and instructions on how to return defective components to Axis.

### DMX INSTALLATION EXAMPLE

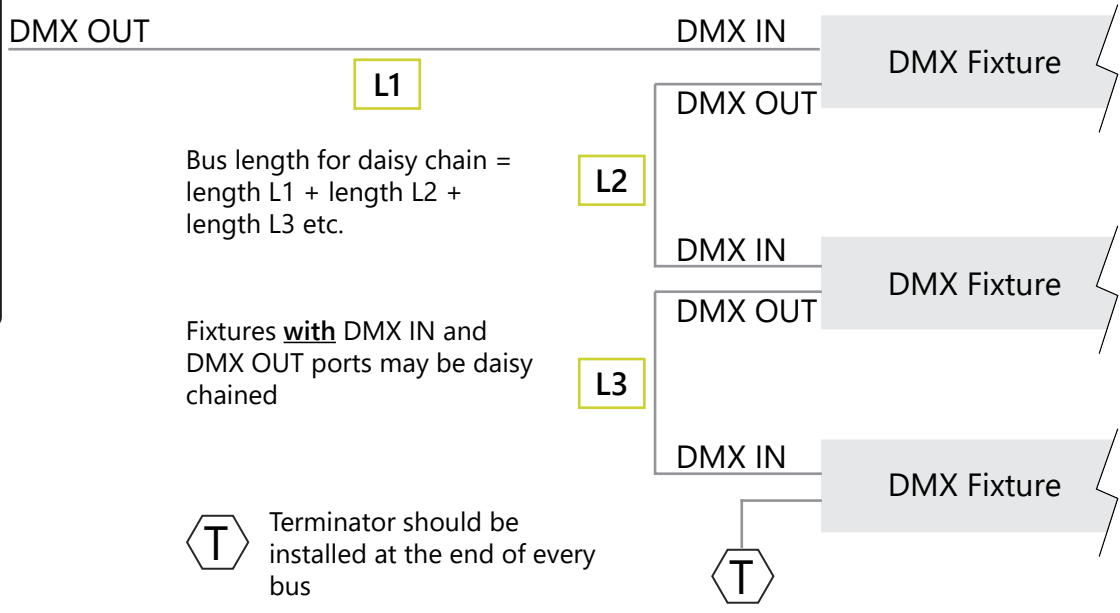

---

**● WHAT IS DMX512 AND RDM**

---

**DMX512A** (Digital Multiplex 512) is a communication standard (based on EIA-485/RS-485) for digital communication networks, typically used in stage lighting and control, but also in other various lighting applications.

DMX drivers are installed in DMX-enabled luminaires and programmed to specific DMX addresses to properly zone and control your fixtures.

**RDM** (Remote Device Management) is a protocol enhancement to DMX512, which allows a commissioner to remotely program multiple or individual DMX decoders to a unique DMX address. This is performed by simply connecting an RDM controller to the first DMX driver in a series run.

All DMX drivers/decoders Axis is using are RDM-compatible.

---

**● DMX GLOSSARY**

---

- **DMX Signal:** a repeating chain data output by a DMX controller, comprised of one 8-bit start code packet followed by 512 8-bit data packets. The first data packet is slot 1, the second slot 2, etc. The entire chain is repeated 44 times per second.
- **Device:** a DMX controller, a DMX-controlled fixture, or a DMX splitter DMX controller: a device where the DMX signal originates (sometimes called a "console")
- **DMX splitter:** a device that receives a DMX signal on its input, then duplicates that signal on its output(s). The input and output signals are usually isolated from each other, and the signal is "boosted" back to full voltage at each output (thereby compensating for voltage drop in long wiring runs). DMX splitters must be powered by their own mains or low-voltage supply.
- **DMX Fixture:** a light fixture that contains a DMX decoder that receives a DMX signal and changes its behavior based on those commands. Fixtures may be equipped with both "input" and "output" connections for the DMX signal.
- **DMX network:** ALL devices, cabling, and interconnections in a DMX controlled lighting system including the controller, fixtures, and splitters (if used)
- **Bus:** a continuous run of daisy-chained devices, originating at the output of a DMX controller or DMX splitter. No more than 32 devices should be connected to a single bus per the DMX-512A standard.
- **Terminator:** a 120Ω resistance installed at the end of a DMX bus to eliminate signal reflection back into the network
- **Channel:** a DMX-controlled element within a DMX fixture. For example an RGB fixture has three channels: one each for red, green, and blue.
- **Address:** the number of the first channel that a DMX fixture reads from the DMX signal

### ● PHOTOMETRIC DATA

#### SO Spotless lens - Down

Downlight  
1000 lm/ft

#### PHOTOMETRIC CURVE

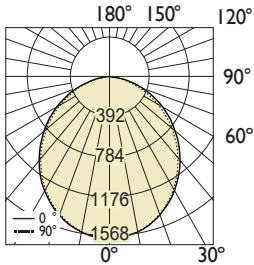

#### CANDELA DISTRIBUTION

Vertical Angle	Horizontal Angles				
	0	22.5	45	67.5	90
0	1566	1566	1566	1566	1566
5	1555	1554	1555	1556	1558
15	1485	1483	1483	1482	1483
25	1351	1347	1346	1341	1342
35	1170	1164	1158	1146	1146
45	955	946	935	920	916
55	722	711	696	676	672
65	483	469	453	430	425
75	254	236	216	194	189
85	60	45	30	20	18
90	4	4	4	4	3

#### ZONAL LUMENS

Zone	Lumens
0	
0-10	148
10-20	418
20-30	620
30-40	724
40-50	723
50-60	625
60-70	453
70-80	238
80-90	51
90	

#### LUMINANCE DATA (cd/m<sup>2</sup>)

Vertical Angle	Horizontal Angles		
	0	45	90
45	12022	11772	11534
55	11207	10806	10439
65	10182	9539	8946
75	8729	7449	6519
85	6128	3111	1836

**Total Lumens: 3958 lm (for 4ft)**

**Input Watts: 52.42 W**

**Efficacy: 75.5 lm/W**

IES FILE: SK4xx-LIN(4)-AL(4)-1000-90-CTRGBW35-SO.ies

TESTED ACCORDING TO IES LM-79-2019

**i** All IES files are available for download at: [www.axislighting.com](http://www.axislighting.com)

**IMPORTANT – all patterns must be submitted with drawings indicating size and radii dimensions.**

