

Sketch 4

PERIMETER - IP54

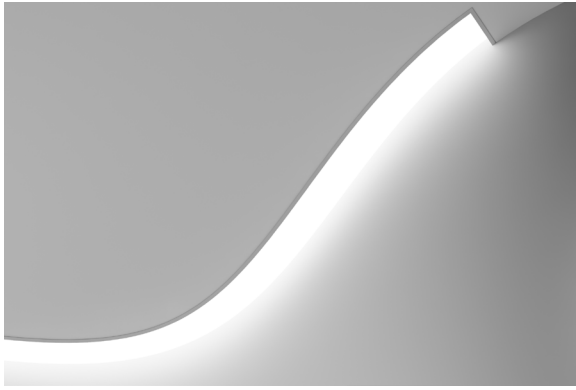

Project _____
 Type _____
 Notes _____

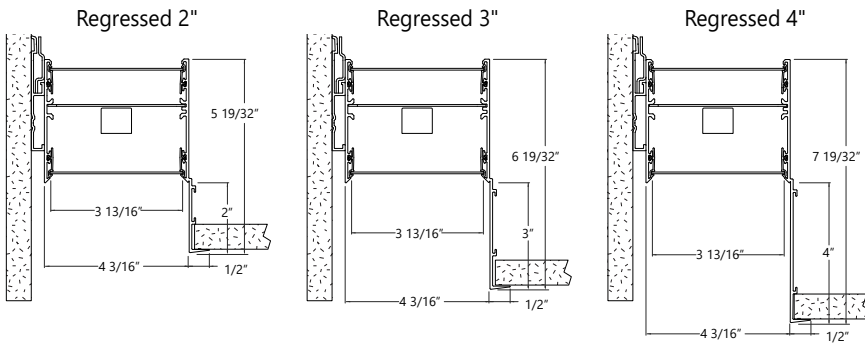

Ordering Guide

SK4PRS-FF(101010)*-AL(9'2")-1000-90-35-SO-RG2-W-120-DP-1-DF

*Project reference number provided by Axis

SK4PRS		PATTERNS AND FORMS		TOTAL LENGTH, CORNER QTY.		LUMENS/FT		CRI
PRODUCT ID		FF(#)	free form pattern (project reference #)*	AL(X'XX")	specify total linear length in feet (2 ft minimum)	300	300 lm/ft - min	90 high efficacy 90 CRI
SK4PRS	Sketch 4 Perimeter Recessed Sealed - IP54 rated	ARC(R, Deg.)	arc (radius, degrees)	+CRN(#)	sharp corner (qty.)	1400	1400 lm/ft - max	
		LIN(L)	linear (length)			1050	1050 lm/ft - max for RG4	
		*Please provide pattern drawing, and specify project reference number. Factory is available for assistance. Regular lit corners (min 45 degrees) available.				Outputs between listed are available. Consult factory for outputs outside of the listed range.		

COLOUR TEMP.		SHIELDING		SHIELDING POSITION		FINISH		VOLTAGE		DRIVER	
27	2700 K	SO	spotless lens	FL	spotless lens	AP	aluminum	120	120V	DP	dimming (0-10V) 1% - integral
35	3500 K			RG2	regressed 2"		paint	277	277V	DALI2	integral driver DALI 2.0 Type 6 - integral
30	3000 K			RG3	regressed 3"	W	white	347	347V*	LT(#)	Lutron - remote*
40	4000 K			RG4	regressed 4"	BLK	black	UNV	universal	O(#)	other - remote**
TW2750	2700-5000 K - Tunable White					C	custom	DC	low voltage**	O(DMX)	other (Digital Multiplex)- remote**
TW2765	2700-6500 K - Tunable White									TW(#)	tunable white drivers - remote*
										POE(#)	POE drivers - remote*
								* Remote only. ** Only available with POE drivers.		* Specify system; see page 2. **Please consult factory; see page 2	

CIRCUITS		MOUNTING		REMOTE BATTERY (OPT.)		OTHER (OPT.)		CUSTOM (OPT.)	
1	1 circuit	DF	drywall flange	BR(#)	battery pack remote	FW	flex whip (6' std)*	C	custom
2	2 circuits	DS	drywall spackle						
+E(#)	emergency circuit *								
+GTD(#)	generator transfer device * **								
* Specify quantity ** Remote only.				Requires 120V or 277V		* Other lengths available; please consult factory.		Please specify	

● CONSTRUCTION

Housing	Extruded aluminum (0.075" nominal)
Interior reflectors	Sheet aluminum (16 gauge)
Mounting brkts.	14GA Galvanized Steel
Joining brackets.	Die cast aluminum (0.10" nominal)
Incap & Cross Brkt.	Die cast aluminum (0.10" nominal)

● ELECTRICAL

DP driver	integral DP driver. 0-10V 1% dimming standard.
DALI2 driver	integral DALI driver. DALI 2.0 D4i certified driver.
Lutron driver* (Remote)	LDE1 - EcoSystem H-Series (1%)
Other drivers* (Remote)	DMX - Digital Multiplex Xitanium SR - For wireless sensor *Consult factory

Tunable White TW drivers* (Remote)	DALIDT6 - DALI Type 6 (Two DALI Addresses) DALIDT8 - DALI Type 8 (One DALI Address) DPTW - two channel 0-10V dimming: one channel for brightness, one channel for CCT. LDTW - Lutron DALI Type 8 (One DALI address) Tunable White series
---	---

Power over Ethernet POE drivers* (consult factory for more information) UL2108 certified for remote driver	MOLEX IGOR SMARTENGINE O - Other (Consult factory)
--	---

Emergency*	Remote emergency battery pack or emergency circuit optional. *Consult factory
Input Voltage	120V, 277V, 347V, UNV, DC.

i Incorporating these components may have limitations or effect the length of the luminaire, please contact factory for more details.

● SHEILDING

Spotless Lens	Acrylic (0.06" thick).
----------------------	------------------------

● FINISH

Highly reflective, white powder coat finish paint for high efficiency. Matte texture to diffuse glare and lamp image on the surface within the optical chamber exterior. Custom finishes are also available.

● WEIGHT

Approximately 1.75lbs/ft = 0.8kg/ft (linear)

● LED SYSTEM

CRI	Minimum high efficacy 90 color rendering index.
CCT Single Color	Choice of 2700K, 3000K, 3500K and 4000K color temperature with a great color consistency (within 3-step MacAdam ellipse). Both within fixture and fixture to fixture.
LED life	Minimum 50,000h with 85% of lumen maintenance in 25°C ambient temperature, in compliance with IES LM-80 testing measurements.
CCT Axitune Systems	Consult Axitune technical sheet for more information on color technology.
Thermal Management	Aluminum housing acting as the heat sink to maximize life.
Environment	Outdoor under canopy, indoor healthcare and wipe down IP54 rated

● APPROVALS

Certified to CSA standards 
Meets NYC requirements
Suitable for outdoor under canopy, indoor healthcare and wipe down IP54 rated

● WARRANTY

Axis Lighting will warrant defective LEDs, boards, and drivers for 5 years from date of purchase. Warranty is valid if luminaire is installed and used according to specifications. If defective, Axis will send replacement boards or drivers at no cost along with detailed replacement instructions and instructions on how to return defective components to Axis.

Sketch 4

PERIMETER - IP54

SECTION VIEWS

FL Flush
DF Drywall flange

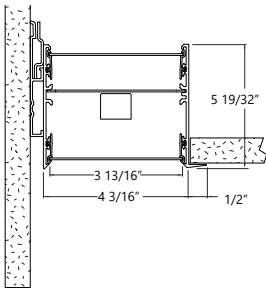

2RG 2" regressed
DF Drywall flange

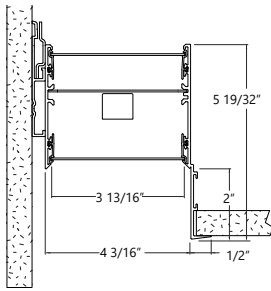

3RG 3" regressed
DF Drywall flange

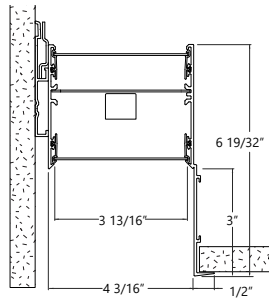

4RG 4" regressed
DF Drywall flange

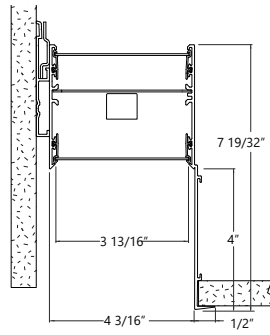

FL Flush
DS Drywall spackle

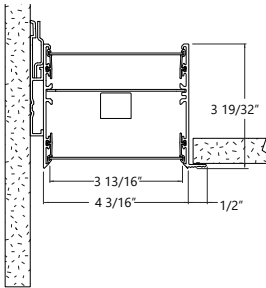

2RG 2" regressed
DS Drywall spackle

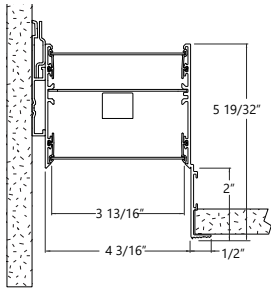

3RG 3" regressed
DS Drywall spackle

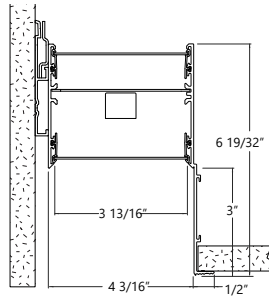

4RG 4" regressed
DS Drywall spackle

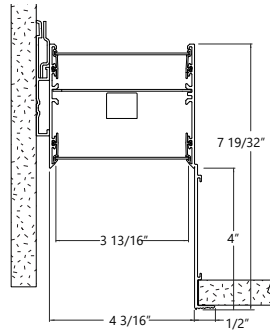

● PHOTOMETRIC DATA

SO Spotless lens - Down

Downlight
1400 lm/ft

PHOTOMETRIC CURVE

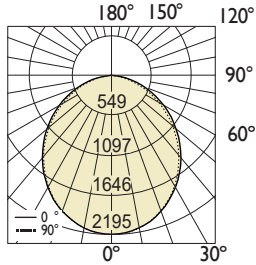

CANDELA DISTRIBUTION

Vertical Angle	Horizontal Angles				
	0	22.5	45	67.5	90
0	2192	2192	2192	2192	2192
5	2176	2175	2178	2179	2181
15	2079	2076	2076	2075	2077
25	1892	1886	1884	1877	1879
35	1638	1630	1622	1604	1604
45	1336	1325	1309	1288	1282
55	1010	995	974	946	941
65	676	656	634	602	594
75	355	330	303	271	265
85	84	64	43	28	25
90	6	6	5	5	5

ZONAL LUMENS

Zone	Lumens
0	
0-10	207
10-20	585
20-30	868
30-40	1014
40-50	1012
50-60	876
60-70	634
70-80	333
80-90	72
90	

LUMINANCE DATA (cd/m²)

Vertical Angle	Horizontal Angles		
	0	45	90
45	16831	16481	16148
55	15689	15129	14615
65	14255	13354	12525
75	12221	10429	9126
85	8579	4355	2570

Total Lumens: 5601 lm (for 4ft)

Input Watts: 43.51 W

Efficacy: 129 lm/W

IES FILE: SK4R-FF-4-1400-90-35-SO-Preliminary.ies

TESTED ACCORDING TO IES LM-79-2019

i All IES files are available for download at: www.axislighting.com

IMPORTANT – all patterns must be submitted with drawings indicating size and radii dimensions.

