

Sketch 3

RECESSED - RGB+W

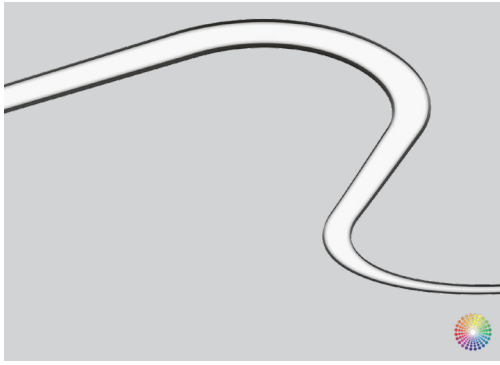

● INTERSECTIONS

Min 45 degree fully lit corner, intersections are one piece lenses with no seams at the intersection.



Project _____

Type _____

Notes _____

● PERFORMANCE PER LINEAR FOOT AT 3500K WHITE

	NOMINAL LUMEN OUTPUT DIRECT	INPUT WATTS*	EFFICACY
Sketch 3	900lm/ft	13.1 W/ft	70.5 lm/W

Please consult factory for other lumen output and wattage.

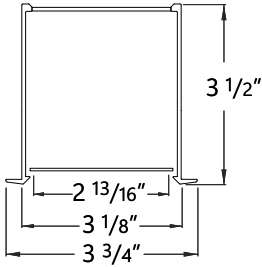

DF drywall flange shown

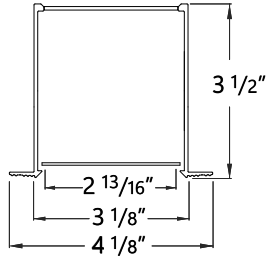

DS drywall spackle flange shown

Ordering Guide

Example: **SK3R-FF(10010*)-AL(7'8'')-900-90-CTRGBW35-SO-BLK-120-CT(DMX)-1-DF**

*Project reference number provided by Axis



SK3R		PATTERNS AND FORMS		TOTAL LENGTH, CORNER QTY.		LUMENS/FT	
PRODUCT ID		FF(#)		AL(X'XX'')		900	900 lm/ft
SK3R	Sketch 3 Recessed RGB+W	FF(#)	free form pattern (project reference #)**	AL(X'XX'')	specify total linear length in feet (4 ft minimum)		
		SSQ(L, R)	soft square (length, radius)*	+INT(#)	intersection (qty.)		
		SR (LxL, R)	soft rectangle (length x width, radius)*	+CRN(#)	sharp corner (qty.)		
		OV(LxL)	oval (length x width)				
		CIR(R)	circle (radius)				
		ARC(R, Deg.)	arc (radius, degrees)				
		LIN(L)	linear (length)				
<p>See page 3 for ordering examples. Min radius 18" and min 4 ft sections. * 4 foot minimum straight sections. **Please provide pattern drawing, and specify project reference number. Factory is available for assistance. Various 2, 3 and 4 leg fully lit intersections and regular lit corners (min 45 degrees) available.</p>							

CRI	COLOUR TEMP.	SHIELDING	FINISH	VOLTAGE	DRIVER
90	high efficacy 90 CRI	SO	AP W BLK C	120 277 UNV	CT(DMX) color tuning driver
	CTRGBW30 RGB+30K White - Color Tuning	spotless lens	aluminum paint	120 V	
	CTRGBW35 RGB+35K White - Color Tuning		white	277 V	
	CTRGBW40 RGB+40K White - Color Tuning		black	universal	
			custom		

CIRCUITS	MOUNTING	OTHER (OPT.)	CUSTOM (OPT.)
1 +E(#)	DF DS	FW	C
1 circuit emergency circuit *	drywall flange drywall spackle flange	flex whip (6' std)*	custom
* Specify quantity		* Other lengths available; please consult factory. Please specify	

How to Specify Standard Forms

Note: The center line indicates the diameter at the center of the curve. Regardless to the mounting style, the center line remains the same. This is the dimension that should be used when planning a layout.

Defining SR - Soft Rectangle shape

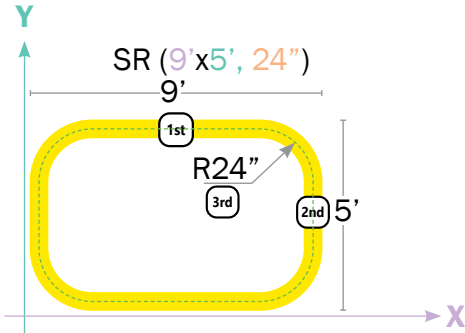

Note: The first number will always define the width, the second - the length. Third number will define the radius of the corner curvature.

Defining SSQ - Soft Square shape

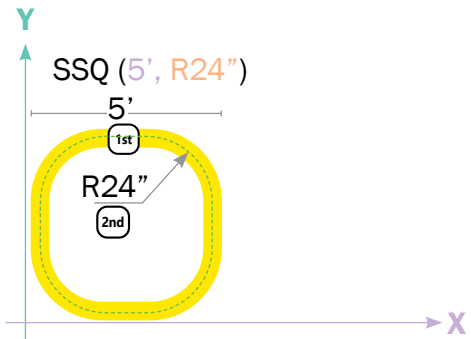

Note: The first number will define the width. (All sides are the same length). The second number will define the radius of the corners curvature.

Defining OV - Oval shape

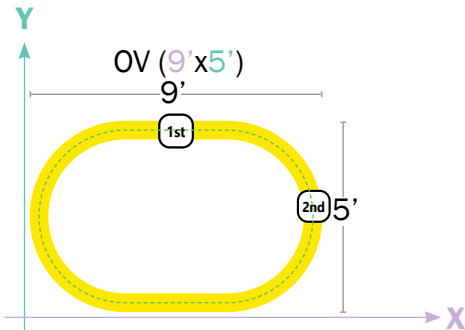

Note: The first number will always define the length. Second number will define the width of the oval shape.

Defining CIR - Circular shape



Note: The number will define the radius of the circle.

Defining ARC - Arc shape

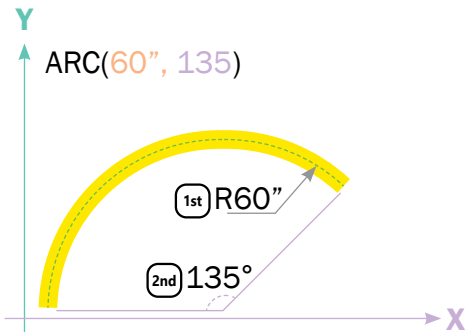

Note: The first number will define the radius of the circle. The second number will define desired arc degree

RADIUS	
R18	18 inch radius
R24	24 inch radius
R30	30 inch radius
R48	48 inch radius
R60	60 inch radius
R72	72 inch radius
R80	80 inch radius
R(XX")	any radius above 12 inch

CONSTRUCTION

Housing	Extruded aluminum (0.075" nominal)
Interior reflectors	Sheet aluminum (20 gauge)
Mounting brkts.	Die cast aluminum (0.10" nominal)
Joining brackets.	Die cast aluminum (0.10" nominal)
Incap & Cross Brkt.	Die cast aluminum (0.10" nominal)

SHEILDING

Spotless Lens Acrylic (0.06" thick).

FINISH

Highly reflective, white powder coat finish paint for high efficiency. Matte texture to diffuse glare and lamp image on the surface within the optical chamber exterior. Custom finishes are also available.

WEIGHT

Approximately 1.75lbs/ft = 0.8kg/ft (linear)

DMX CONNECTION

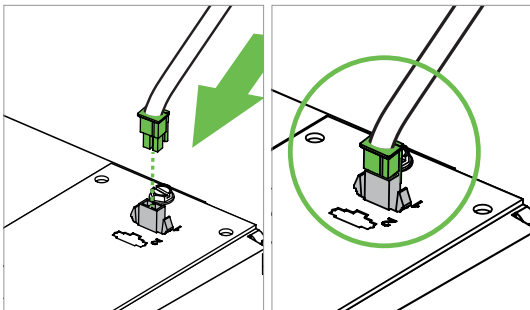

Illustration shows DMX cables that run to luminaire using MOLEX® Quick Connect plug for easy wiring.

Appropriate cables include (but are not limited to) the following:

PLENUM RATED	NON-PLENUM RATED
Belden 82842	Belden 9842 Liberty 24-2P-485
Belden 89842	
Liberty 24-1P-P485	
Liberty 24-2P-P485	

The maximum recommended run length between a single fixture and the DMX controller or splitter where the signal originates (or is boosted in the case of a splitter) is 1000 ft including any cable length between a ceiling canopy and the fixture.

The maximum recommended bus run length between two daisy-chained DMX controlled fixtures is 300 ft.

ELECTRICAL

Color Tuning CT driver	DMX - Standard
Emergency	Emergency circuit optional.
Input Voltage	120V, 277V, UNV.

i Incorporating these components may have limitations or affect the length of the luminaire. Please contact factory for more details.

LED SYSTEM

CRI	High efficacy 90 color rendering index.
CRI Color Tuning	90 CRI for CTRGBW. Note: RGB+W allows you to select the 'white point' (CCT) + CRI, delivering a more flexible and powerful white than standard RGBW.
CCT Color Tuning	30 (3000K) 35 (3500K) 40 (4000K)

CCT Axitune Systems [Consult Axitune technical sheet for more information on color technology.](#)

LED life Minimum 50,000h with 85% of lumen maintenance in 25°C ambient temperature, in compliance with IES LM-80 testing measurements.

Thermal Management Aluminum housing acting as the heat sink to maximize life.

Environment Dry and damp rated in operating ambient temperatures of 0-40°C (32-104F).

APPROVALS

Certified to CSA standards 
Meets NYC requirements
Suitable for damp locations, indoor only.

WARRANTY

Axis Lighting will warrant defective LEDs, boards, and drivers for 5 years from date of purchase. Warranty is valid if luminaire is installed and used according to specifications. If defective, Axis will send replacement boards or drivers at no cost along with detailed replacement instructions and instructions on how to return defective components to Axis.

DMX INSTALLATION EXAMPLE

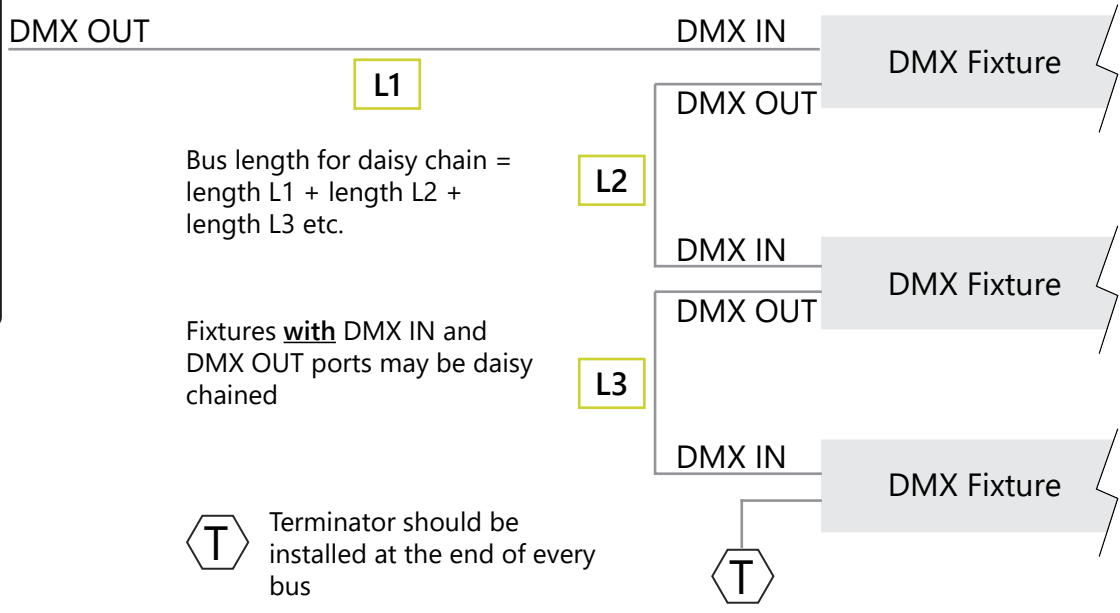

● WHAT IS DMX512 AND RDM

DMX512A (Digital Multiplex 512) is a communication standard (based on EIA-485/RS-485) for digital communication networks, typically used in stage lighting and control, but also in other various lighting applications.

DMX drivers are installed in DMX-enabled luminaires and programmed to specific DMX addresses to properly zone and control your fixtures.

RDM (Remote Device Management) is a protocol enhancement to DMX512, which allows a commissioner to remotely program multiple or individual DMX decoders to a unique DMX address. This is performed by simply connecting an RDM controller to the first DMX driver in a series run.

All DMX drivers/decoders Axis is using are RDM-compatible.

● DMX GLOSSARY

- **DMX Signal:** a repeating chain data output by a DMX controller, comprised of one 8-bit start code packet followed by 512 8-bit data packets. The first data packet is slot 1, the second slot 2, etc. The entire chain is repeated 44 times per second.
- **Device:** a DMX controller, a DMX-controlled fixture, or a DMX splitter DMX controller: a device where the DMX signal originates (sometimes called a "console")
- **DMX splitter:** a device that receives a DMX signal on its input, then duplicates that signal on its output(s). The input and output signals are usually isolated from each other, and the signal is "boosted" back to full voltage at each output (thereby compensating for voltage drop in long wiring runs). DMX splitters must be powered by their own mains or low-voltage supply.
- **DMX Fixture:** a light fixture that contains a DMX decoder that receives a DMX signal and changes its behavior based on those commands. Fixtures may be equipped with both "input" and "output" connections for the DMX signal.
- **DMX network:** ALL devices, cabling, and interconnections in a DMX controlled lighting system including the controller, fixtures, and splitters (if used)
- **Bus:** a continuous run of daisy-chained devices, originating at the output of a DMX controller or DMX splitter. No more than 32 devices should be connected to a single bus per the DMX-512A standard.
- **Terminator:** a 120Ω resistance installed at the end of a DMX bus to eliminate signal reflection back into the network
- **Channel:** a DMX-controlled element within a DMX fixture. For example an RGB fixture has three channels: one each for red, green, and blue.
- **Address:** the number of the first channel that a DMX fixture reads from the DMX signal

● PHOTOMETRIC DATA

SO Spotless lens - Down

Downlight
900 lm/ft

PHOTOMETRIC CURVE

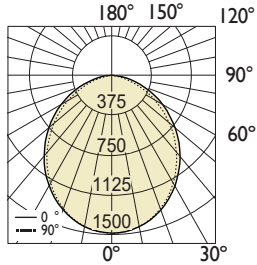

CANDELA DISTRIBUTION

Vertical Angle	Horizontal Angles				
	0	22.5	45	67.5	90
0	1500	1500	1500	1500	1500
5	1491	1490	1491	1491	1493
15	1423	1421	1421	1417	1417
25	1293	1288	1285	1275	1272
35	1114	1110	1097	1079	1072
45	906	898	880	853	845
55	681	672	647	613	603
65	454	440	411	375	364
75	232	217	187	158	148
85	58	43	28	19	17
90	4	4	4	3	3

ZONAL LUMENS

Zone	Lumens
0	
0-10	141
10-20	399
20-30	588
30-40	681
40-50	672
50-60	571
60-70	401
70-80	198
80-90	40
90	

LUMINANCE DATA (cd/m²)

Vertical Angle	Horizontal Angles		
	0	45	90
45	15664	15223	14620
55	14510	13799	12847
65	13134	11906	10534
75	10971	8820	6972
85	8199	3876	2451

Total Lumens: 3693 lm (for 4ft)

Input Watts: 52.42 W

Efficacy: 70 lm/W

IES FILE: SK3xx-LIN(4)-AL(4)-900-90-CTRGBW35-SO 1.ies

TESTED ACCORDING TO IES LM-79-2019

i All IES files are available for download at: www.axislighting.com

IMPORTANT – all patterns must be submitted with drawings indicating size and radii dimensions.

