

Sketch 2

RECESSED - IP54

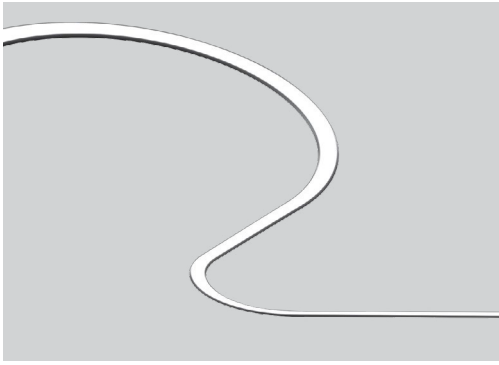

Project _____
 Type _____
 Notes _____

● PERFORMANCE PER LINEAR FOOT AT 3500K, 90CRI

	NOMINAL LUMEN OUTPUT DIRECT	INPUT WATTS*	EFFICACY
Sketch 2	1100lm/ft	9.85 W/ft	112 lm/W

Please consult factory for other lumen output and wattage.

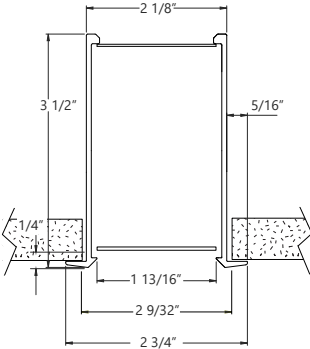

RADIUS	
R12	12 inch radius
R24	24 inch radius
R30	30 inch radius
R48	48 inch radius
R60	60 inch radius
R72	72 inch radius
R84	84 inch radius
R(XX")	any radius above 12"

Sketch 2 is designed to accommodate any curve radius over 12 inches. Pattern drawing is required. Factory is available for assistance.

Ordering Guide

Example: SK2RS-FF(10010*)-AL(7'8")-1000-90-35-SO-BLK-120-DP-1-DF

*Project reference number provided by Axis



SK2RS		PATTERNS AND FORMS		TOTAL LENGTH		LUMENS/FT	
PRODUCT ID		SSQ(L, R)	soft square (length, radius)*	AL(X'XX")	specify total linear length in feet (2 ft minimum)	300	300 lm/ft- Low
SK2RS	Sketch 2 Recessed Sealed - IP54 rated	SR (LxL, R)	soft rectangle (length x width, radius)*			1100	1100 lm/ft - High
		OV(LxL)	oval (length x width)				
		CIR(R)	circle (radius)				
		ARC(R, Deg.)	arc (radius, degrees)				
		LIN(L)	linear (length)				
		FF(#)	free form pattern (project reference #)**				
See page 2 for ordering examples. * 2 foot minimum straight sections. **Please provide pattern drawing, and specify project reference number. Factory is available for assistance. Various 2, 3 and 4 leg intersections and regular lit corners (min 45 degrees) available.						Outputs between listed are available. Consult factory for outputs outside of the listed range.	

CRI	COLOUR TEMP.	SHIELDING	FINISH	VOLTAGE	DRIVER
90 high efficacy 90 CRI	27 2700 K 30 3000 K 35 3500 K 40 4000 K TW2750 2700-5000 K - Tunable White TW2765 2700-6500 K - Tunable White	SO spotless lens	AP aluminum paint W white BLK black C custom	120 120V 277 277V UNV universal 347 347V* DC low voltage**	DP dimming (0-10V) 1% - integral DALI2 integral driver DALI 2.0 Type 6 - integral LT(#) Lutron - remote* O(#) other - remote** TW(#) tunable white drivers - remote* POE(#) POE drivers - remote*
				* Remote only. ** Only available with POE drivers.	* Specify system; see page 3. **Please consult factory; see page 3

CIRCUITS		MOUNTING		REMOTE BATTERY (OPT.)		OTHER (OPT.)		CUSTOM (OPT.)	
1	1 circuit	DF	drywall flange	BR(#)	battery pack remote	FW	flex whip (6' std)*	C	custom
2	2 circuits	DS	drywall spackle flange	B(#)	battery pack - integral*				
+E(#)	emergency circuit *								
+GTD(#)	generator transfer device * **								
* Specify quantity ** Remote only.		Specify quantity		*4 foot length minimum and 36" radius minimum		* Other lengths available; please consult factory.		Please specify	

● CONSTRUCTION

Housing	Extruded aluminum (0.075" nominal)
Interior reflectors	Sheet aluminum (20 gauge)
Mounting brkts.	Die cast aluminum (0.10" nominal)
Joining brackets.	Die cast aluminum (0.10" nominal)
Incap & Cross Brkt.	Die cast aluminum (0.10" nominal)

● SHEILDING

Spotless Lens	Acrylic (0.06" thick).
----------------------	------------------------

● IP54 SYSTEM

System runs are comprised of a combination of sections to be assembled on site using our joining system which includes a clear silicone gasket for almost seamless construction for IP54 rating.

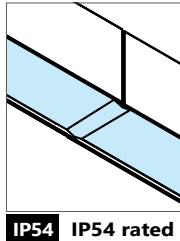

● FINISH

Highly reflective, white powder coat finish paint for high efficiency. Matte texture to diffuse glare and lamp image on the surface within the optical chamber exterior. Custom finishes are also available.

● ELECTRICAL

DP driver	integral DP driver. 0-10V 1% dimming standard.
DALI2 driver	integral DALI driver. DALI 2.0 D4i certified driver.
Lutron driver* (Remote)	LDE1 - EcoSystem H-Series (1%)
Other drivers* (Remote)	DMX - Digital Multiplex Xitanium SR - For wireless sensor *Consult factory
Tunable White TW drivers* (Remote)	DALIDT6 - DALI Type 6 (Two DALI Addresses) DALIDT8 - DALI Type 8 (One DALI Address) DPTW - two channel 0-10V dimming: one channel for brightness, one channel for CCT. LDTW - Lutron DALI Type 8 (One DALI address) Tunable White series
Power over Ethernet POE drivers* (consult factory for more information) UL2108 certified for remote driver	MOLEX IGOR SMARTENGINE O - Other (Consult factory)
Emergency*	Remote emergency battery pack or emergency circuit optional. *Consult factory
Input Voltage	120V, 277V, 347V, UNV, DC.

i Incorporating these components may have limitations or effect the length of the luminaire, please contact factory for more details.

● LED SYSTEM

CRI	High efficacy 90 color rendering index.
CCT Single Color	Choice of 2700K, 3000K, 3500K and 4000K color temperature with a great color consistency (within 3-step MacAdam ellipse). Both within fixture and fixture to fixture.
LED life	Minimum 50,000h with 85% of lumen maintenance in 25°C ambient temperature, in compliance with IES LM-80 testing measurements.
CCT Axitune Systems	Consult Axitune technical sheet for more information on color technology.
Thermal Management	Aluminum housing acting as the heat sink to maximize life.
Environment	Outdoor under canopy, indoor healthcare and wipe down IP54 rated

● WEIGHT

Approximately 1.75lbs/ft = 0.8kg/ft (linear)

● APPROVALS

Certified to CSA standards 
Meets NYC requirements
Suitable for outdoor under canopy, indoor healthcare and wipe down IP54 rated. .

● WARRANTY

Axis Lighting will warrant defective LEDs, boards, and drivers for 5 years from date of purchase. Warranty is valid if luminaire is installed and used according to specifications. If defective, Axis will send replacement boards or drivers at no cost along with detailed replacement instructions and instructions on how to return defective components to Axis.

How to Specify Standard Forms

Note: The center line indicates the diameter at the center of the curve. Regardless to the mounting style, the center line remains the same. This is the dimension that should be used when planning a layout.

Defining SR - Soft Rectangle shape

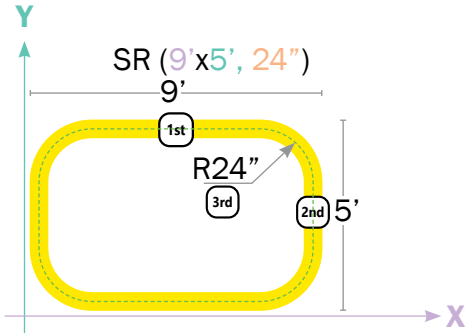

Note: The first number will always define the width, the second - the length. Third number will define the radius of the corner curvature.

Defining SSQ - Soft Square shape

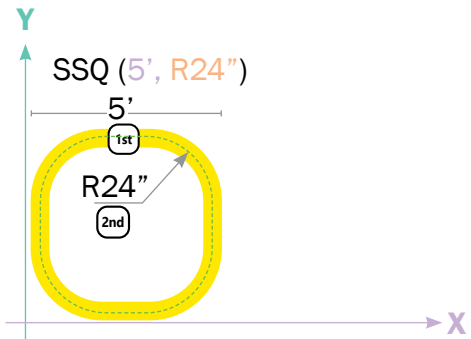

Note: The first number will define the width. (All sides are the same length). The second number will define the radius of the corners curvature.

Defining OV - Oval shape

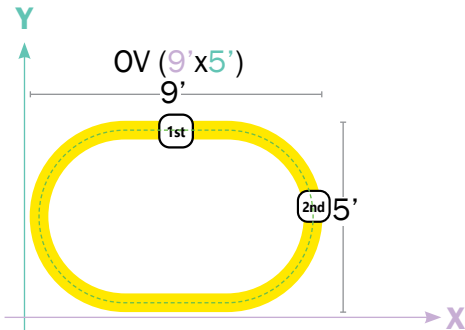

Note: The first number will always define the length. Second number will define the width of the oval shape.

Defining CIR - Circular shape



Note: The number will define the radius of the circle.

Defining ARC - Arc shape

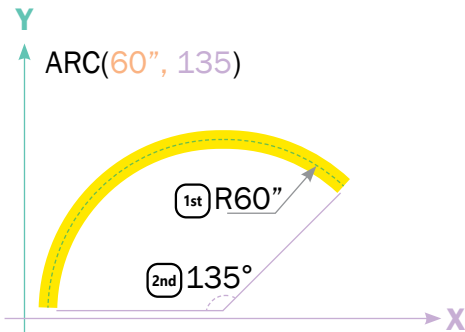

Note: The first number will define the radius of the circle. The second number will define desired arc degree

RADIUS	
R12	12 inch radius
R18	18 inch radius
R24	24 inch radius
R30	30 inch radius
R48	48 inch radius
R60	60 inch radius
R72	72 inch radius
R80	80 inch radius
R(XX'')	any radius above 12 inch

● PHOTOMETRIC DATA

SO Spotless lens - Down

Downlight
1100 lm/ft

PHOTOMETRIC CURVE

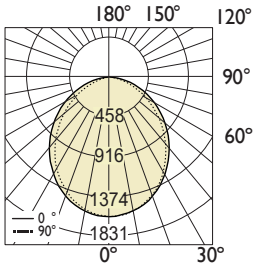

CANDELA DISTRIBUTION

Vertical Angle	Horizontal Angles				
	0	22.5	45	67.5	90
0	1830	1830	1830	1830	1830
5	1824	1817	1816	1809	1811
15	1739	1728	1720	1704	1704
25	1582	1557	1536	1515	1507
35	1355	1330	1304	1264	1254
45	1101	1073	1038	977	956
55	830	802	741	674	660
65	552	518	454	395	380
75	288	243	193	151	143
85	71	38	19	14	14
90	5	5	4	4	4

ZONAL LUMENS

Zone	Lumens
0	
0-10	172
10-20	486
20-30	712
30-40	819
40-50	802
50-60	673
60-70	466
70-80	227
80-90	44
90	

LUMINANCE DATA (cd/m²)

Vertical Angle	Horizontal Angles		
	0	45	90
45	25408	23959	22065
55	23612	21072	18775
65	21313	17524	14662
75	18139	12140	9006
85	13344	3503	2604

Total Lumens: 4401 lm (for 4ft)

Input Watts: 39.4 W

Efficacy: 112 lm/W

IES FILE: SK2R-FF-4'-1100-90-35-SO.ies

TESTED ACCORDING TO IES LM-79-2019

i All IES files are available for download at: www.axislighting.com

IMPORTANT – all patterns must be submitted with drawings indicating size and radii dimensions.

