

Sketch 2

RING RECESSED WITH MIKROLITE

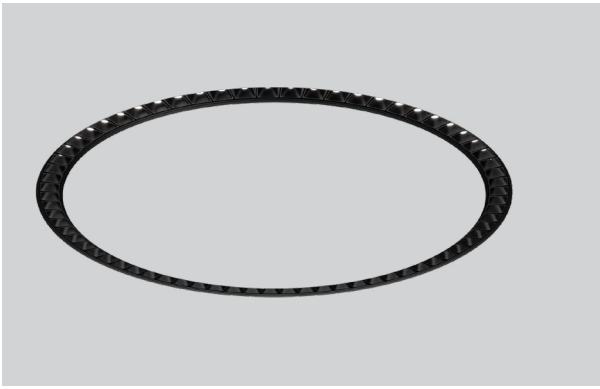

Project _____
 Type _____
 Notes _____

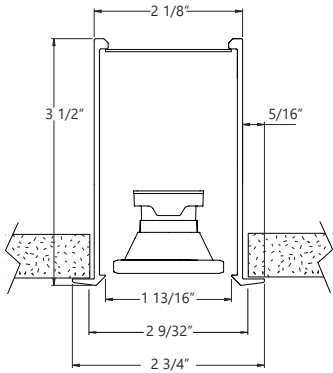

DF Drywall flange shown

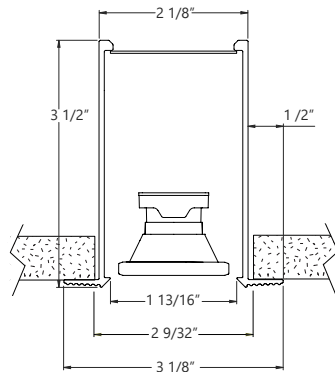

DS Drywall spackle flange shown

● PERFORMANCE PER LINEAR FOOT AT 3500K, 90CRI

	NOMINAL LUMEN OUTPUT INDIRECT	NOMINAL LUMEN OUTPUT DIRECT	INPUT WATTS*	EFFICACY
SO	1200lm/ft	1100lm/ft	19.2 W/ft	120 lm/W

● PERFORMANCE PER LINEAR FOOT MIKROLITE AT 3500K, 90CRI

BAFFLE	BEAM ANGLE	FINISH	NOM. LUMEN OUTPUT	INPUT WATTS*	EFFICACY
Conic	SF-D50	White	1000lm/ft	10 W/ft	97 lm/W
Conic	SR-D50	White	1000lm/ft	9.1 W/ft	107 lm/W
Lofted	SF-D50	White	1000lm/ft	9.8 W/ft	99 lm/W
Lofted	SR-D50	White	1000lm/ft	8.7 W/ft	112 lm/W

Please consult factory for other lumen output and wattage.

● MIKROLITE BEAM SPREADS

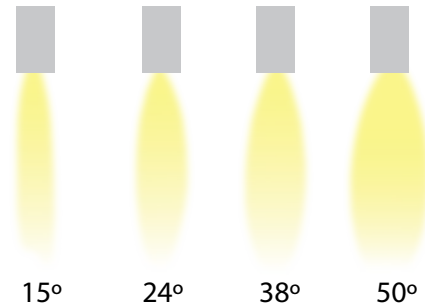

● MIKROLITE BAFFLE TYPE

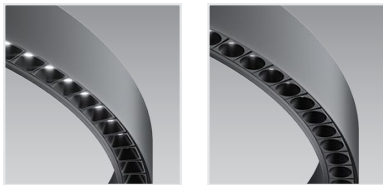

LF
Lofted baffle

CN
Conical baffle

● MIKROLITE BAFFLE FINISHES



MW matte white
MB matte black
MS matte silver
MRG matte rose gold
CG chrome gold



CL crystal
CB chrome black
CS chrome silver
CRG chrome rose gold

Ordering Guide

Example: SK2RML-D(36")-AL(9' 5 3/32")-MKL(FL,LF,SF,D38,750,MB)-90-35-DP-1-BLK-120-DF

PRODUCT ID	PATTERNS AND FORMS	CORRESPONDING TOTAL LENGTH
SK2RML Sketch 2 Recessed Combined with Mikrolite	D(24") diameter 24"	AL(6' 3 6/16")
	D(36") diameter 36"	AL(9' 5 2/16")
	D(48") diameter 48"	AL(13' 6 13/16")
	D(60") diameter 60"	AL(16' 8 8/16")
	D(72") diameter 72"	AL(19' 10 3/16")
	D(84") diameter 84"	AL(22' 11 14/16")
	D(96") diameter 96"	AL(25' 1 9/16")
See page 4 for ordering examples.		

SHIELDING OPTIONS					
MikroLite - MKL (Length, Baffle Type, Cell Optics, Beam Angle, Lumen, Baffle Finish)					
LENGTH	BAFFLE TYPE	CELL OPTICS	BEAM ANGLE	LUMEN OUTPUT	BAFFLE FINISH
FL full length	LF lofted baffle	SF soft beam ¹	D15 15 deg	200 200 lm/ft min	MB matte black
	CN conical baffle	SR sharp beam ²	D24 24 deg	1000 1000 lm/ft max	MW matte white
			D38 38 deg	Any lumen output available within range +/- 5%	MS matte silver
			D50 50 deg		MRG matte rose gold
					CG chrome gold
				CB chrome black	
				CRG chrome rose gold	
				CS chrome silver	
				CL crystal	

7 cell min, with 1 cell (1.5") increments.

CRI	COLOUR TEMP.	FINISH	VOLTAGE	DRIVER	CIRCUITS
90 high efficacy 90 CRI	27 2700 K	AP aluminum paint	120 120V	DP dimming (0-10V) 1% - integral	1 1 circuit
	35 3500 K	W white	277 277V	DALI2 integral driver DALI 2.0 Type 6 - integral	2 2 circuits
	30 3000 K	BLK black	347 347V*	LT(#) Lutron - remote*	+E(#) emergency circuit *
	40 4000 K	C custom	UNV universal	O(#) other - remote**	+GTD(#) generator transfer device * **
			DC low voltage**	O(DMX) other (Digital Multiplex) - remote**	
			POE(#) POE drivers - remote*		
			* Remote only. ** Only available with POE drivers.	* Specify system; see page 3. ** Please consult factory; see page 3	* Specify quantity ** Remote only.

MOUNTING/SUSPENSION	REMOTE BATTERY (OPT.)	OTHER (OPT.)	CUSTOM (OPT.)
DF drywall flange DS drywall spackle flange	BR(#) battery pack remote	FW flex whip (6' std)* CP Chicago plenum	C custom
		* Other lengths available; please consult factory.	Please specify

● CONSTRUCTION

Housing	Extruded aluminum (0.075" nominal)
Interior reflectors	Sheet aluminum (20 gauge)
Mounting brkts.	Die cast aluminum (0.10" nominal)
Joining brackets.	Die cast aluminum (0.10" nominal)
Incap & Cross Brkt.	Die cast aluminum (0.10" nominal)

● ELECTRICAL

DP driver	integral DP driver. 0-10V 1% dimming standard.
DALI2 driver	integral DALI driver. DALI 2.0 D4i certified driver.
Lutron driver* (Remote)	LDE1 - EcoSystem H-Series (1%)
Other drivers* (Remote)	DMX - Digital Multiplex Xitanium SR - For wireless sensor *Consult factory
Power over Ethernet POE drivers* (consult factory for more information) UL2108 certified for remote driver	MOLEX IGOR SMARTENGINE O - Other (Consult factory)
Emergency*	Remote emergency battery pack or emergency circuit optional. *Consult factory
Input Voltage	120V, 277V, 347V, UNV, DC.

i Incorporating these components may have limitations or effect the length of the luminaire, please contact factory for more details.

● SHEILDING

Spotless Lens	Acrylic (0.06" thick).
----------------------	------------------------

● FINISH

Highly reflective, white powder coat finish paint for high efficiency. Matte texture to diffuse glare and lamp image on the surface within the optical chamber exterior. Custom finishes are also available.

● WEIGHT

Approximately 1.75lbs/ft = 0.8kg/ft (linear)

● LED SYSTEM

CRI	High efficacy 90 color rendering index.
CCT Single Color	Choice of 2700K, 3000K, 3500K and 4000K color temperature with a great color consistency (within 3-step MacAdam ellipse). Both within fixture and fixture to fixture.
LED life	Minimum 50,000h with 85% of lumen maintenance in 25°C ambient temperature, in compliance with IES LM-80 testing measurements.
Thermal Management	Aluminum housing acting as the heat sink to maximize life.
Environment	Dry and damp rated in operating ambient temperatures of 0-40°C (32-104F).

● APPROVALS

Certified to CSA standards 
Meets NYC requirements
Suitable for damp locations, indoor only.

● WARRANTY

Axis Lighting will warrant defective LEDs, boards, and drivers for 5 years from date of purchase. Warranty is valid if luminaire is installed and used according to specifications. If defective, Axis will send replacement boards or drivers at no cost along with detailed replacement instructions and instructions on how to return defective components to Axis.

How to Specify Standard Rings

Note: The center line indicates the diameter at the center of the curve. Regardless to the mounting style, the center line remains the same. This is the dimension that should be used when planning a layout.

Defining Rings - Circular shape

Example: SK2RML-D(36")-AL(9' 5 3/32")-MKL(FL,LF,SF,D38,750,MB)-90-35-DP-1-BLK-120-DF

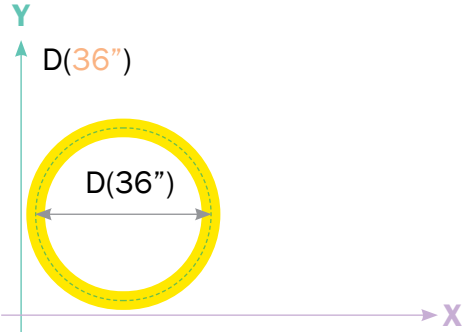

Note: The number will define the diameter of the circle.

● PHOTOMETRIC DATA MIKROLITE - CONIC BAFFLE

MikroLite - 4ft - 50 deg
1000 lm/ft

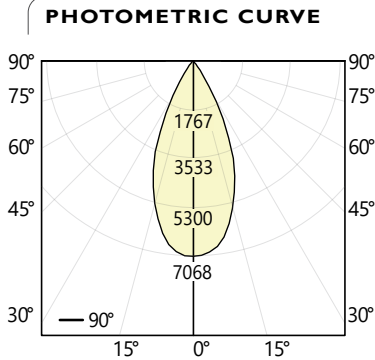

Vertical Angle	Horizontal Angles				
	0	22.5	45	67.5	90
0	7066	7066	7066	7066	7066
5	6947	6902	6880	6841	6862
15	5519	5404	5364	5265	5298
25	3078	2993	2979	2827	2855
35	673	657	673	609	589
45	91	83	81	73	74
55	13	13	13	13	13
65	10	10	10	10	10
75	5	5	5	5	5
85	2	2	2	1	2
90	1	1	0	0	0

Zone	Lumens
	0
0-10	1495
10-20	1328
20-30	438
30-40	70
40-50	12
50-60	9
60-70	5
70-80	1
80-90	
90	

Vertical Angle	Horizontal Angles		
	0	45	90
45	2705	2406	2200
55	479	487	482
65	481	484	482
75	444	448	447
85	441	412	374

Conic Baffle, Soft Beam, White Matte Finish.

Direct Output: 1000 lm/ft
Total Lumens: 4001 lm (for 4ft)
Input Watts: 38.7 W
Efficacy: 103 lm/W*

* Efficacy reduces up to 20% with dark baffle finishes.

IES FILE: MKL-4-FL-CN-SF-D50-1000-MW-90-35.ies
 TESTED ACCORDING TO IES LM-79-2019

MikroLite - 4ft - 50 deg
1000 lm/ft

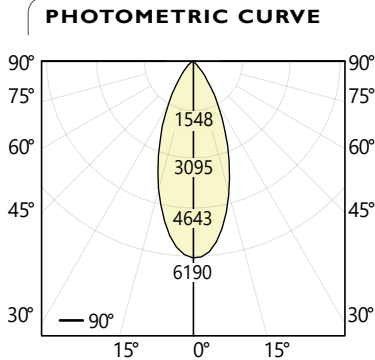

Vertical Angle	Horizontal Angles				
	0	22.5	45	67.5	90
0	6190	6190	6190	6190	6190
5	6017	6009	6022	5995	6008
15	4374	4375	4400	4360	4406
25	2409	2424	2478	2447	2465
35	1019	1026	1065	1041	1052
45	300	305	324	321	327
55	106	105	110	111	115
65	35	35	35	35	35
75	17	17	17	17	17
85	5	5	5	5	5
90	1	1	1	1	1

Zone	Lumens
	0
0-10	1170
10-20	1072
20-30	622
30-40	243
40-50	94
50-60	35
60-70	17
70-80	5
80-90	
90	

Vertical Angle	Horizontal Angles		
	0	45	90
45	8960	9680	9774
55	3885	4063	4238
65	1763	1759	1772
75	1403	1399	1425
85	1213	1243	1299

Conic Baffle, Sharp Beam, White Matte Finish.

Direct Output: 950 lm/ft
Total Lumens: 3800 lm (for 4ft)
Input Watts: 37.5 W
Efficacy: 101 lm/W*

* Efficacy reduces up to 20% with dark baffle finishes.

IES FILE: MKL-4-FL-CN-SR-D50-950-MW-90-35.ies
 TESTED ACCORDING TO IES LM-79-2019

i All IES files are available for download at: www.axislighting.com

● PHOTOMETRIC DATA MIKROLITE - LOFTED BAFFLE

MikroLite - 4ft - 50 deg
1000 lm/ft

PHOTOMETRIC CURVE

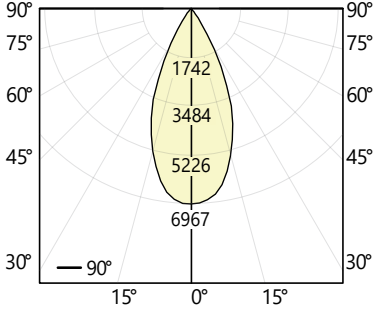

Vertical Angle	Horizontal Angles				
	0	22.5	45	67.5	90
0	6966	6966	6966	6966	6966
5	6815	6805	6812	6794	6821
15	5426	5347	5339	5265	5286
25	3023	2903	2900	2815	2828
35	674	663	684	632	570
45	102	105	116	91	81
55	7	8	9	8	8
65	4	4	5	5	5
75	3	3	3	3	3
85	1	1	1	1	1
90	1	1	1	0	0

Zone	Lumens
	0
0-10	1484
10-20	1319
20-30	461
30-40	87
40-50	8
50-60	8
60-70	4
70-80	2
80-90	1
90	

Vertical Angle	Horizontal Angles		
	0	45	90
45	3032	3469	2408
55	260	331	281
65	211	240	247
75	207	233	242
85	242	250	232

Lofted Baffle, Soft Beam, White Matte Finish.

Direct Output: 1000 lm/ft
Total Lumens: 4000 lm (for 4ft)
Input Watts: 38.3 W
Efficacy: 104 lm/W*

* Efficacy reduces up to 20% with dark baffle finishes.

IES FILE: MKL-4-FL-LF-SF-D50-1000-MW-90-35.ies
 TESTED ACCORDING TO IES LM-79-2019

MikroLite - 4ft - 50 deg
1000 lm/ft

PHOTOMETRIC CURVE

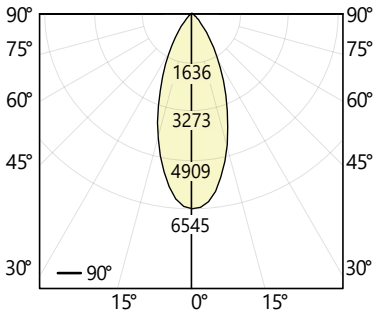

Vertical Angle	Horizontal Angles				
	0	22.5	45	67.5	90
0	6545	6545	6545	6545	6545
5	6342	6260	6232	6207	6238
15	4546	4425	4410	4359	4391
25	2493	2435	2438	2370	2379
35	1061	1047	1064	1008	986
45	310	336	396	318	290
55	102	105	112	101	93
65	29	29	30	27	27
75	14	13	13	13	13
85	4	4	4	3	3
90	1	1	1	1	1

Zone	Lumens
	0
0-10	1225
10-20	1115
20-30	663
30-40	279
40-50	98
50-60	31
60-70	14
70-80	4
80-90	
90	

Vertical Angle	Horizontal Angles		
	0	45	90
45	9266	11822	8645
55	3743	4133	3428
65	1465	1489	1334
75	1148	1068	1033
85	1029	884	839

Lofted Baffle, Sharp Beam, White Matte Finish.

Direct Output: 1000 lm/ft
Total Lumens: 4000 lm (for 4ft)
Input Watts: 38.0 W
Efficacy: 105 lm/W*

* Efficacy reduces up to 20% with dark baffle finishes.

IES FILE: MKL-4-FL-LF-SR-D50-1000-MW-90-35.ies
 TESTED ACCORDING TO IES LM-79-2019

i All IES files are available for download at: www.axislighting.com

● PHOTOMETRIC DATA MIKROLITE - CLASSIC BAFFLE

MikroLite - 4ft - 50 deg
1000 lm/ft

PHOTOMETRIC CURVE

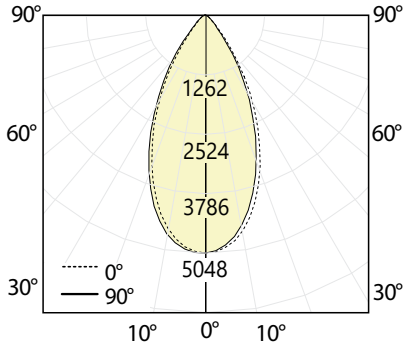

CANDELA DISTRIBUTION					
Vertical Angle	Horizontal Angles				
	0	22.5	45	67.5	90
0	5048	5048	5048	5048	5048
5	4894	4899	4914	4930	4952
15	3906	3941	4011	4052	4100
25	2397	2443	2521	2585	2641
35	1014	1111	1195	1209	1192
45	291	330	441	370	350
55	128	140	145	152	147
65	48	60	66	67	61
75	26	28	28	31	31
85	5	6	7	9	10
90	1	1	1	1	1

ZONAL LUMENS	
Zone	Lumens
0	461
0-10	1127
10-20	1188
20-30	769
30-40	320
40-50	138
50-60	67
60-70	31
70-80	9
80-90	9
90	9

LUMINANCE DATA (cd/m ²)			
Vertical Angle	Horizontal Angles		
	0	45	90
45	8718	13196	10471
55	4733	5363	5410
65	2418	3305	3077
75	2157	2320	2570
85	1278	1692	2314

Classic Baffle, Soft Beam, White Finish

Direct Output: 1000 lm/ft
Total Lumens: 4111 lm (for 4ft)
Input Watts: 36.3 W
Efficacy: 113 lm/W

IES FILE: SCDMLO-4-1000-90-35-D55-W-ST.IES
 TESTED ACCORDING TO IES LM-79-2019

MikroLite - 4ft - 50 deg
1000 lm/ft

PHOTOMETRIC CURVE

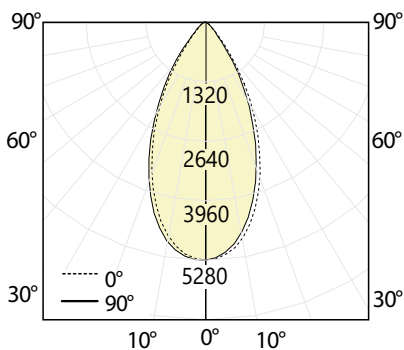

CANDELA DISTRIBUTION					
Vertical Angle	Horizontal Angles				
	0	22.5	45	67.5	90
0	5280	5280	5280	5280	5280
5	5152	5150	5149	5150	5147
15	4155	4165	4169	4158	4142
25	2652	2654	2635	2650	2638
35	1099	1188	1300	1246	1144
45	326	338	393	349	335
55	99	102	78	103	103
65	1	4	12	4	0
75	0	0	0	0	0
85	0	0	0	0	0
90	0	1	0	0	0

ZONAL LUMENS	
Zone	Lumens
0	479
0-10	1152
10-20	1208
20-30	767
30-40	291
40-50	91
50-60	11
60-70	0
70-80	0
80-90	0
90	0

LUMINANCE DATA (cd/m ²)			
Vertical Angle	Horizontal Angles		
	0	45	90
45	9614	11563	9852
55	3603	2826	3751
65	32	577	0
75	0	0	0
85	0	0	0

Classic Baffle, Soft Beam, Black Finish

Direct Output: 1000 lm/ft
Total Lumens: 4000 lm (for 4ft)
Input Watts: 39.2 W
Efficacy: 102 lm/W

IES FILE: SCDMLO-4-1000-90-35-D55-BLK-ST.IES
 TESTED ACCORDING TO IES LM-79-2019

i All IES files are available for download at: www.axislighting.com

PHOTOMETRIC DATA MIKROLITE NARROW AND MEDIUM BEAMS

MikroLite - 4ft - 38 deg
1000 lm/ft

PHOTOMETRIC CURVE

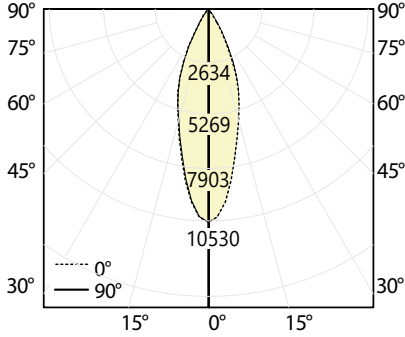

Vertical Angle	Horizontal Angles				
	0	22.5	45	67.5	90
0	10538	10538	10538	10538	10538
5	9592	9576	9544	9530	9519
15	5764	5365	4928	5301	5658
25	2902	2507	2252	2554	2868
35	406	564	833	568	430
45	65	75	135	80	69
55	22	25	27	27	24
65	3	5	6	5	3
75	0	0	0	0	0
85	0	0	0	0	0
90	0	0	0	0	0

Zone	Lumens
	0
0-10	1488
10-20	1156
20-30	409
30-40	78
40-50	24
50-60	6
60-70	0
70-80	0
80-90	0
90	

Vertical Angle	Horizontal Angles		
	0	45	90
45	2210	4566	2329
55	928	1149	987
65	153	359	182
75	0	0	0
85	0	0	0

Classic Baffle, Soft Beam, Black Finish

Direct Output: 1000 lm/ft
Total Lumens: 4000 lm (for 4ft)
Input Watts: 40 W
Efficacy: 100 lm/W

IES FILE: SCDML0-4-1000-90-35-D38-BLK-ST
 TESTED ACCORDING TO IES LM-79-2019

MikroLite - 4ft - 15 deg
1000 lm/ft

PHOTOMETRIC CURVE

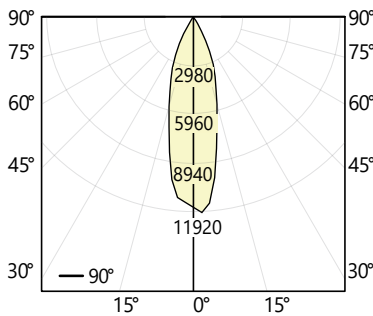

Vertical Angle	Horizontal Angles				
	0	22.5	45	67.5	90
0	11568	11568	11568	11568	11568
5	11410	11178	11181	11091	11360
15	5858	5704	5642	5441	5521
25	2541	2400	2381	2260	2306
35	355	316	314	280	276
45	13	12	12	12	11
55	8	7	7	7	7
65	6	5	5	5	5
75	3	3	3	3	3
85	1	1	1	1	1
90	0	0	0	0	0

Zone	Lumens
	0
0-10	1623
10-20	1128
20-30	243
30-40	11
40-50	6
50-60	5
60-70	3
70-80	1
80-90	
90	

Vertical Angle	Horizontal Angles		
	0	45	90
45	381	366	338
55	281	257	247
65	275	244	237
75	245	217	214
85	214	187	184

Conic Baffle, Soft Beam, White Matte Finish.

Direct Output: 1000 lm/ft
Total Lumens: 4000 lm (for 4ft)
Input Watts: 37.7 W
Efficacy: 106 lm/W*

* Efficacy reduces up to 20% with dark baffle finishes.

IES FILE: MKL-4-FL-CN-SF-D15-1000-MW-90-35.ies
 TESTED ACCORDING TO IES LM-79-2019

i All IES files are available for download at: www.axislighting.com

PHOTOMETRIC DATA MIKROLITE NARROW AND MEDIUM BEAMS

MikroLite - 4ft - 24 deg
1000 lm/ft

PHOTOMETRIC CURVE

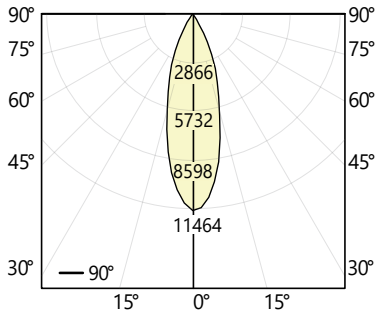

CANDELA DISTRIBUTION

Vertical Angle	Horizontal Angles				
	0	22.5	45	67.5	90
0	11464	11464	11464	11464	11464
5	10742	10752	10727	10634	10653
15	6108	6121	6192	6052	5973
25	2602	2660	2751	2641	2625
35	380	403	461	405	371
45	8	8	8	7	7
55	6	6	5	5	5
65	5	4	4	4	4
75	3	3	3	3	3
85	1	1	1	1	2
90	1	1	1	1	1

ZONAL LUMENS

Zone	Lumens
0	
0-10	931
10-20	1637
20-30	1143
30-40	266
40-50	10
50-60	5
60-70	4
70-80	3
80-90	1
90	

LUMINANCE DATA (cd/m²)

Vertical Angle	Horizontal Angles		
	0	45	90
45	244	235	220
55	212	203	199
65	233	222	224
75	259	255	261
85	346	362	378

Conic Baffle, Soft Beam, White Matte Finish.

Direct Output: 1000 lm/ft
Total Lumens: 4001 lm (for 4ft)
Input Watts: 36.1 W
Efficacy: 111 lm/W*

* Efficacy reduces up to 20% with dark baffle finishes.

IES FILE: MKL-4-FL-CN-SF-D24-1000-MW-90-35.ies
 TESTED ACCORDING TO IES LM-79-2019

MikroLite - 4ft - 38 deg
1000 lm/ft

PHOTOMETRIC CURVE

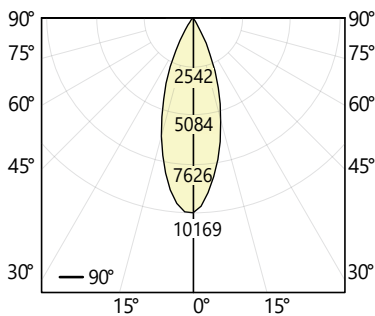

CANDELA DISTRIBUTION

Vertical Angle	Horizontal Angles				
	0	22.5	45	67.5	90
0	10169	10169	10169	10169	10169
5	9552	9408	9312	9168	9163
15	6211	5993	5878	5677	5627
25	2645	2456	2382	2186	2100
35	442	407	389	331	310
45	28	25	23	20	19
55	9	8	8	8	7
65	5	5	5	5	5
75	3	3	3	3	3
85	2	2	2	1	1
90	1	1	1	1	1

ZONAL LUMENS

Zone	Lumens
0	
0-10	853
10-20	1658
20-30	1150
30-40	294
40-50	28
50-60	8
60-70	5
70-80	3
80-90	1
90	

LUMINANCE DATA (cd/m²)

Vertical Angle	Horizontal Angles		
	0	45	90
45	843	673	574
55	331	296	274
65	260	243	243
75	274	255	251
85	399	372	343

Conic Baffle, Soft Beam, White Matte Finish.

Direct Output: 1000 lm/ft
Total Lumens: 4001 lm (for 4ft)
Input Watts: 37.5 W
Efficacy: 107 lm/W*

* Efficacy reduces up to 20% with dark baffle finishes.

IES FILE: MKL-4-FL-CN-SF-D38-1000-MW-90-35.ies
 TESTED ACCORDING TO IES LM-79-2019

i All IES files are available for download at: www.axislighting.com